

**CONTROL PANEL PARTS**

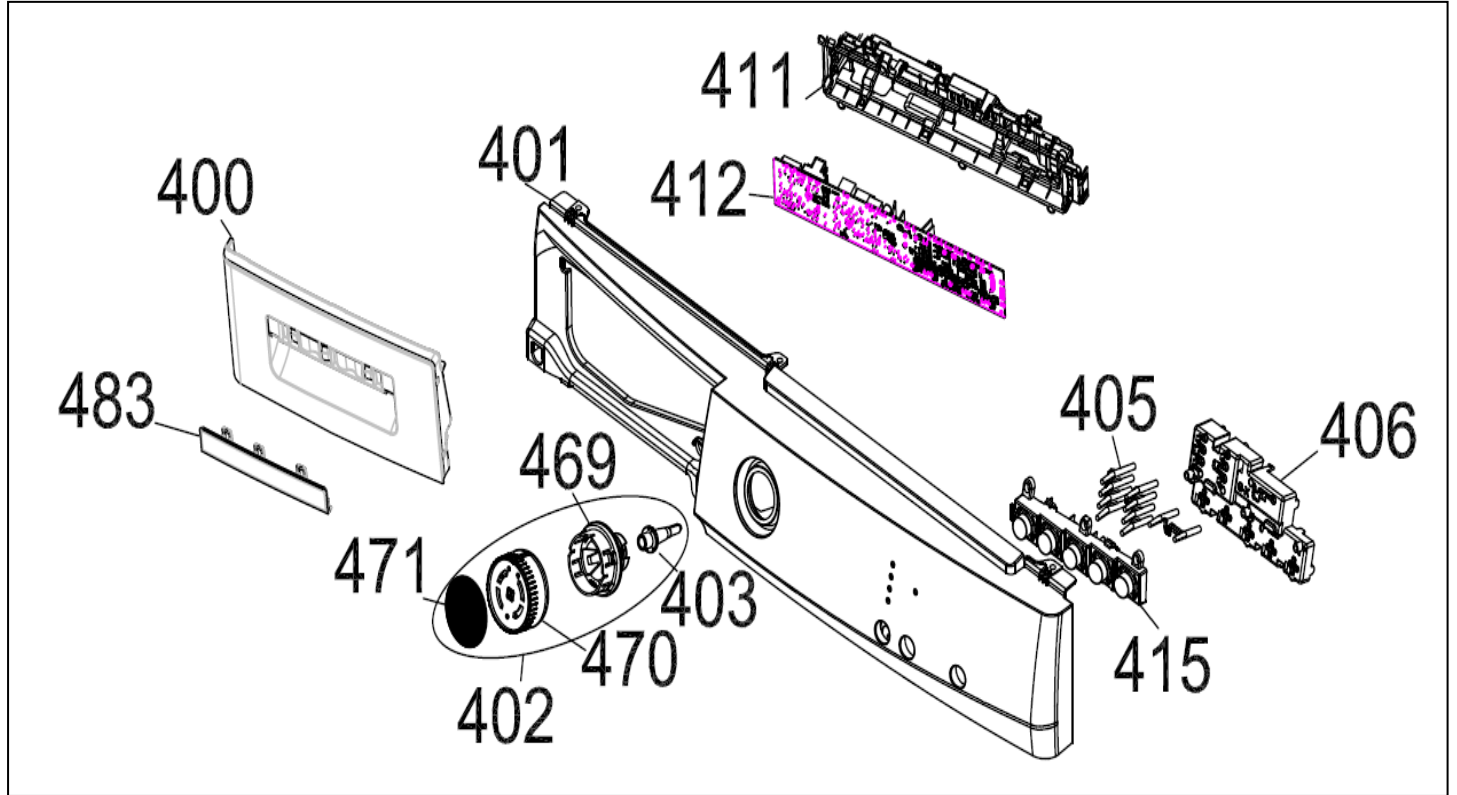

NO	PART NAME	QUANTITY
400	DETERGENT DRAWER COVER	1
401	CONTROL PANEL	1
402	PR. ADJUSTMENT KNOB GR (470+471)	1
403	PROGRAMME ADJUSTMENT SHAFT	1
405	LIGHT GUIDE DUO	1
406	BUTTON&LIGHTGUIDE BOX	1
411	PCB BOX	1
412	ELECTRONIC CARD-W.FOIL	1
415	TRIPLE SELECTION BUTTON	1
469	PROGRAM ADJ. INSERT	1
470	PROGRAM ADJ. KNOB	1
471	PROGRAM ADJ. KNOB COVER	1
483	DETERGENT DRAWER COVER INSERT	1
500	CONTROL PANEL GROUP ( indicated for the website)	1

**FRONT PANEL PARTS**

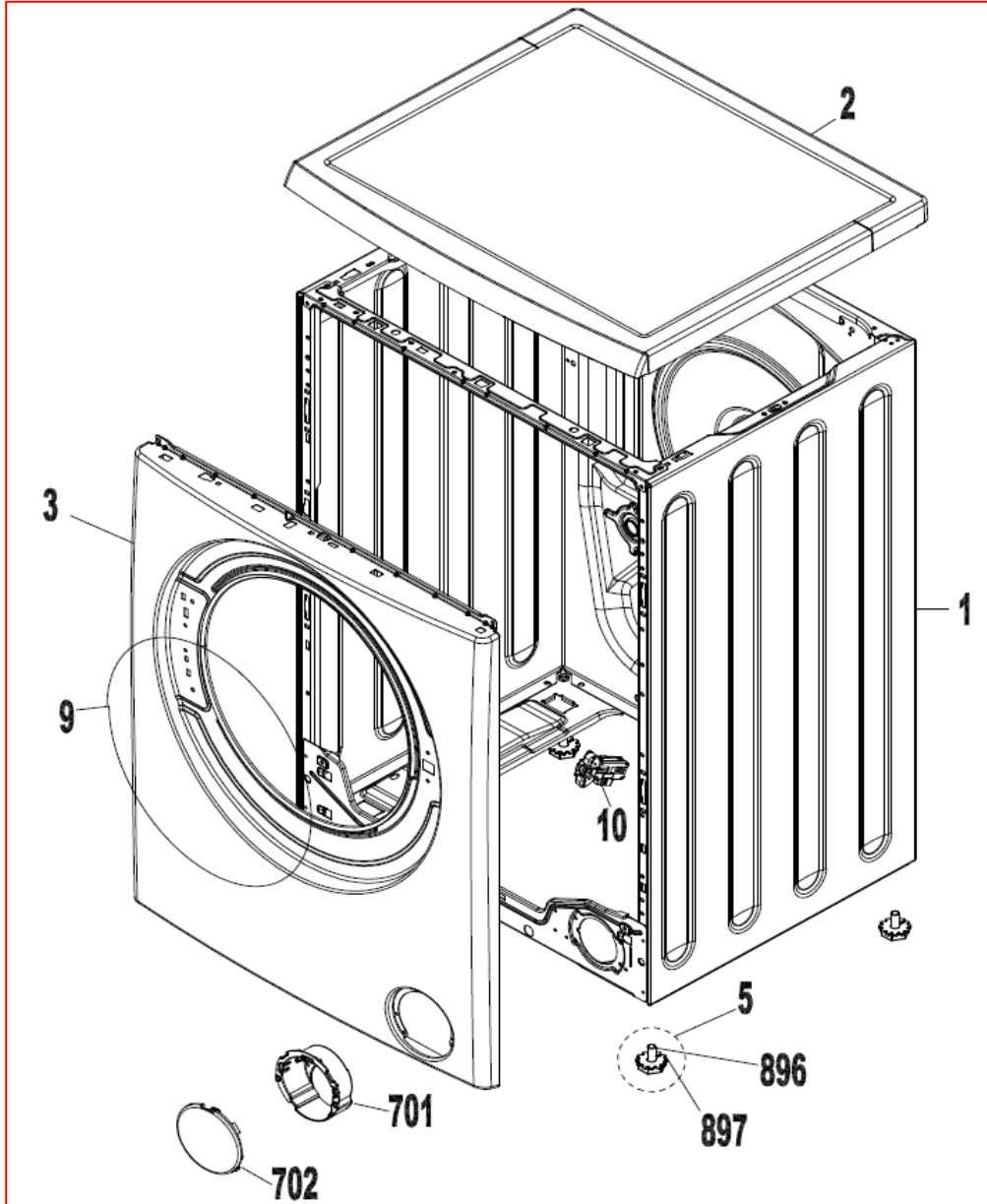

NO	PART NAME	QUANTITY
1	BODY GROUP PAINTED	1
2	UPPER TRAY GROUP	1
3	FRONT PANEL GROUP	1
4	PLINTH GROUP (includes 22+23)	1
5	ADJUSTABLE FEET	4
9	BODY-GASKET CLAMP	1
10	DOOR LOCK	1
701	PUMP COVER HOUSING	1
702	PUMP COVER	1
896	SCREW M10*30	4
897	ADJUSTED FOOT ADJUST STAMP PLS.	4

**WASHING GROUP PARTS**

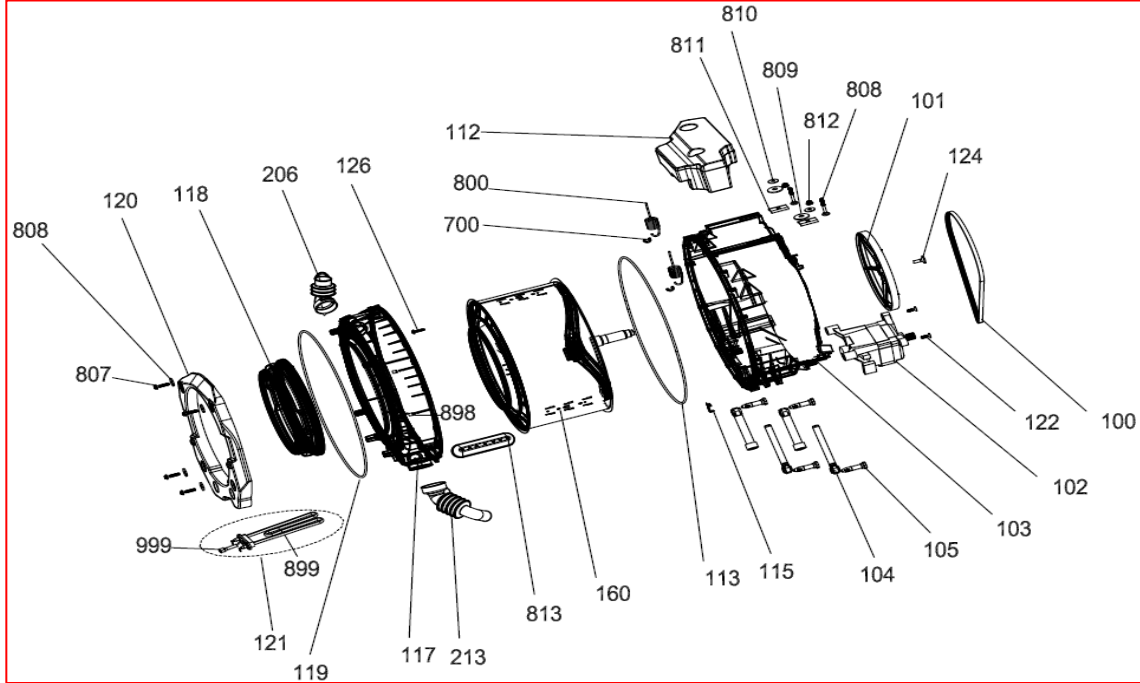

NO	PART NAME	QUANTITY
100	BELT	1
101	DRIVEN PULLEY	1
102	MOTOR	1
103	REAR TUB GROUP	1
104	SHOCK ABSORBER	2
105	SHOCK ABSORBER PIM	2
112	UPPER COUNTERWEIGHT	1
113	TUB SEAL	1
115	RESISTANCE FIXING WIRE	1
117	FRONT TUB	1
118	TUB BELLOWS SEAL	1
119	TUB BELLOW CLIP	1
120	FRONT COUNTERWEIGHT	1
121	RESISTANCE GROUP	1
122	COUNTERSUNK HEAD BOLT 8X25 TORK	2
124	COUNTERSUNK HEAD BOLD M 8X29	1
126	HEXAGON HEAD BOLT 6 X 30	12
160	DRUM GROUP	1
206	TUB ENTERANCE WITH BELLOW HOSE	1
213	TUB EXIT WITH BELLOW HOSE	1
700	TUB HANGER SPRING PART	2
800	HANGER SPRING	2
807	HEXAGON HEAD BOLT 8X40	4
808	WASHER 8,4X28X3	4
809	WASHER 8,5X35X3	2
811	UPPER CONCRETE SUPPORT SHEET IRON PART	2
812	NUT M8	2
813	PLASTIC LIFTER	1
810	UPPER COUNTERWEIGHT WASHER 9X30X3	3
898	PSW HOSE MOUNTING RUBBER	2
899	RESISTANCE WITHOUT NTC	1
999	NTC	1

**DETERGENT DRAWER GROUP**

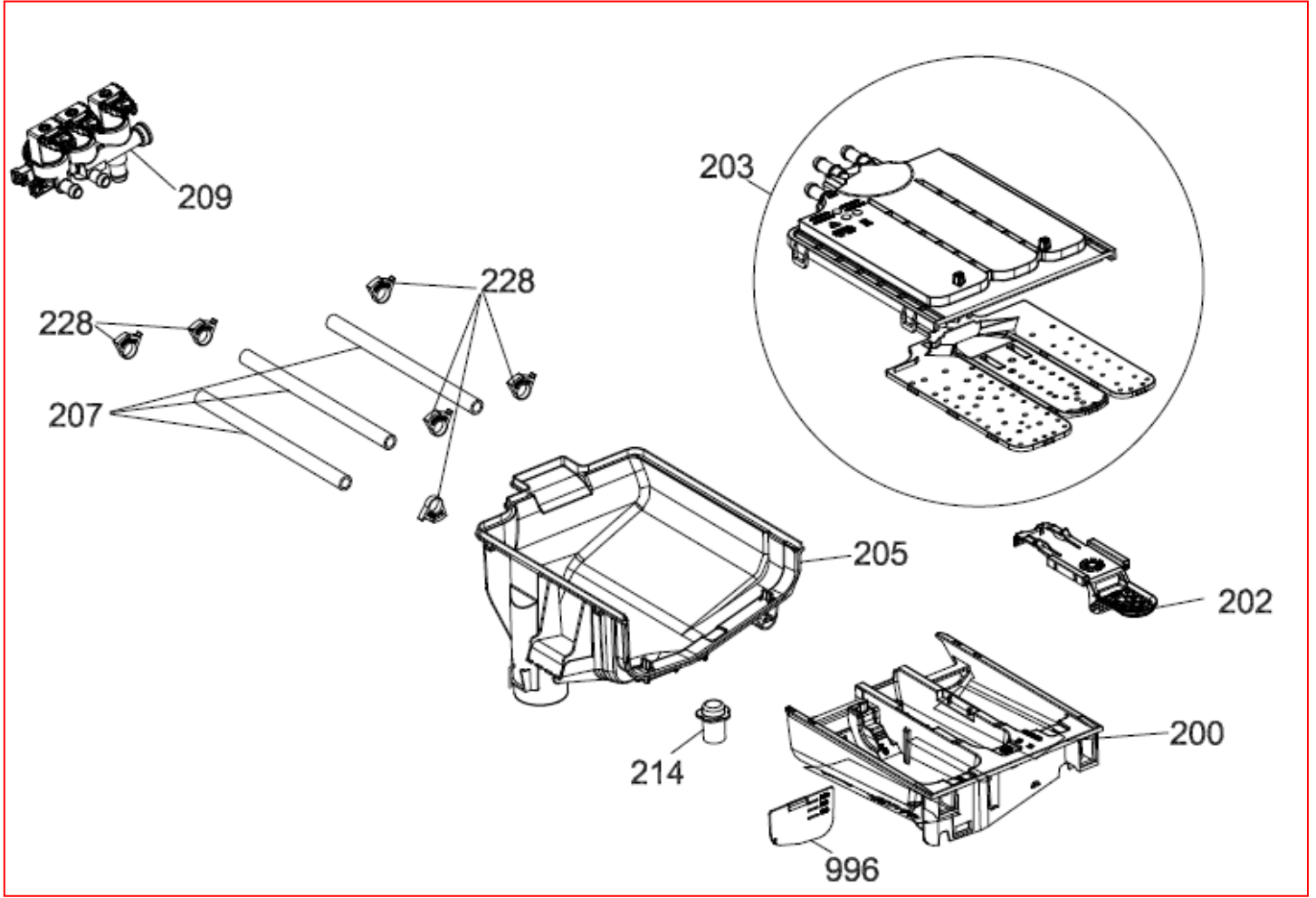

NO	PART NAME	QUANTITY
200	DETERGENT DRAWER	1
202	SIPHON COVER	1
203	WATER DISTRIBUTION PLATE GROUP	1
205	DETERGENT DRAWER HOUSING	1
207	VALVE-DETERGENT BOX HOSE	1
209	VALVE(TWO EXIT)	1
214	DETERGENT DRAWER LOCKING PART	1
228	PLASTIC HOSE CLAMP	6
996	LIQUID DETERGENT LEVEL PLATE	1

**PRESSURE SWITCH HOSE GROUP**

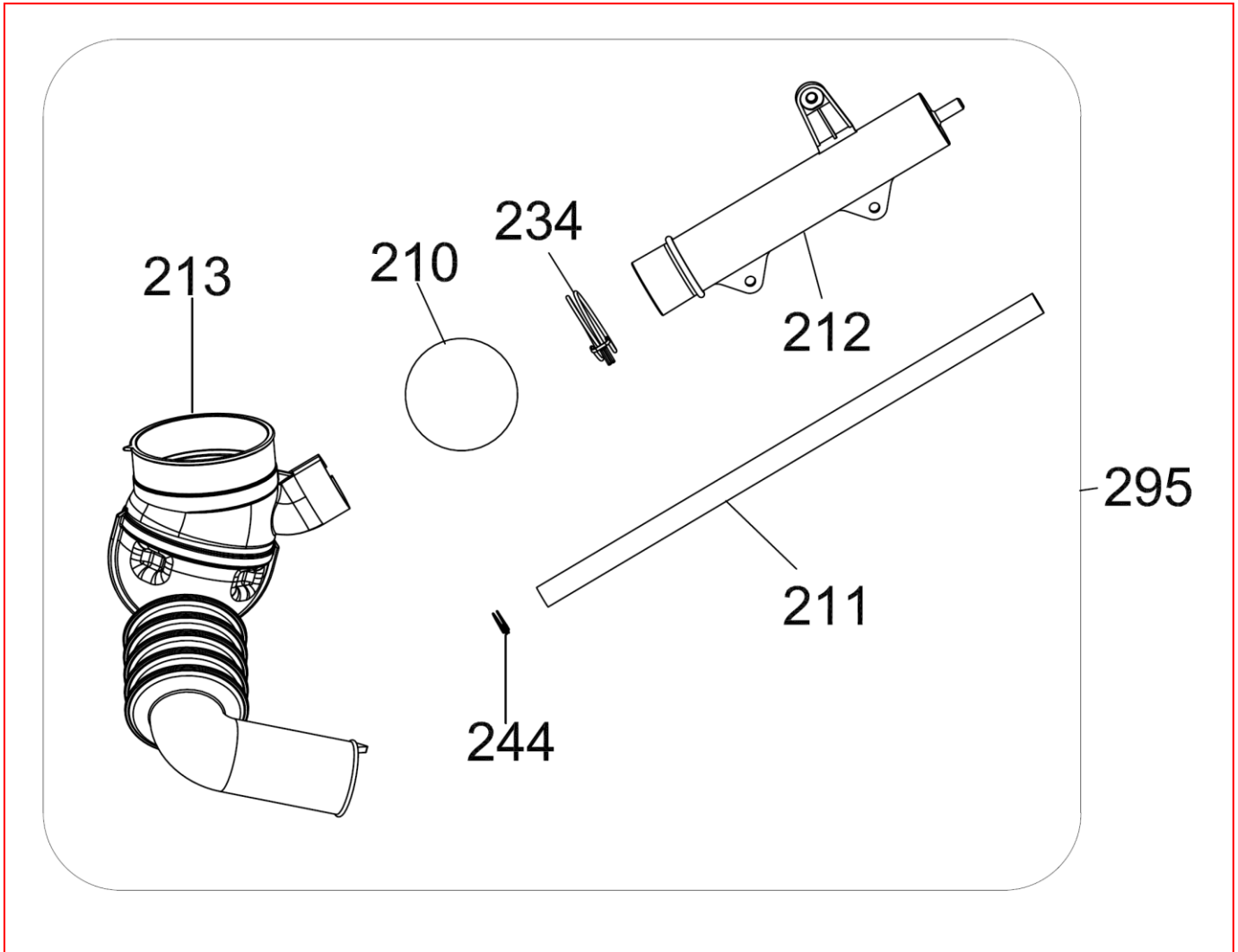

NO	PART NAME	QUANTITY
210	TUB EXIT BELLOW HOSE BALL	1
213	TUB EXIT WITH BELLOW HOSE	1
212	PRESSURE SWITCH WATER RESERVOIR	1
211	PRESSURE SWITCH HOSE	1
234	HOSE CLAMP Ø32,7	1
244	HOSE CLAMP Ø9,6	1
295	PRESSURE SWITCH HOSE GROUP	1

213-212-211-234-244----- PRESSURE SWITCH HOSE GROUP

**BODY GROUP PARTS**

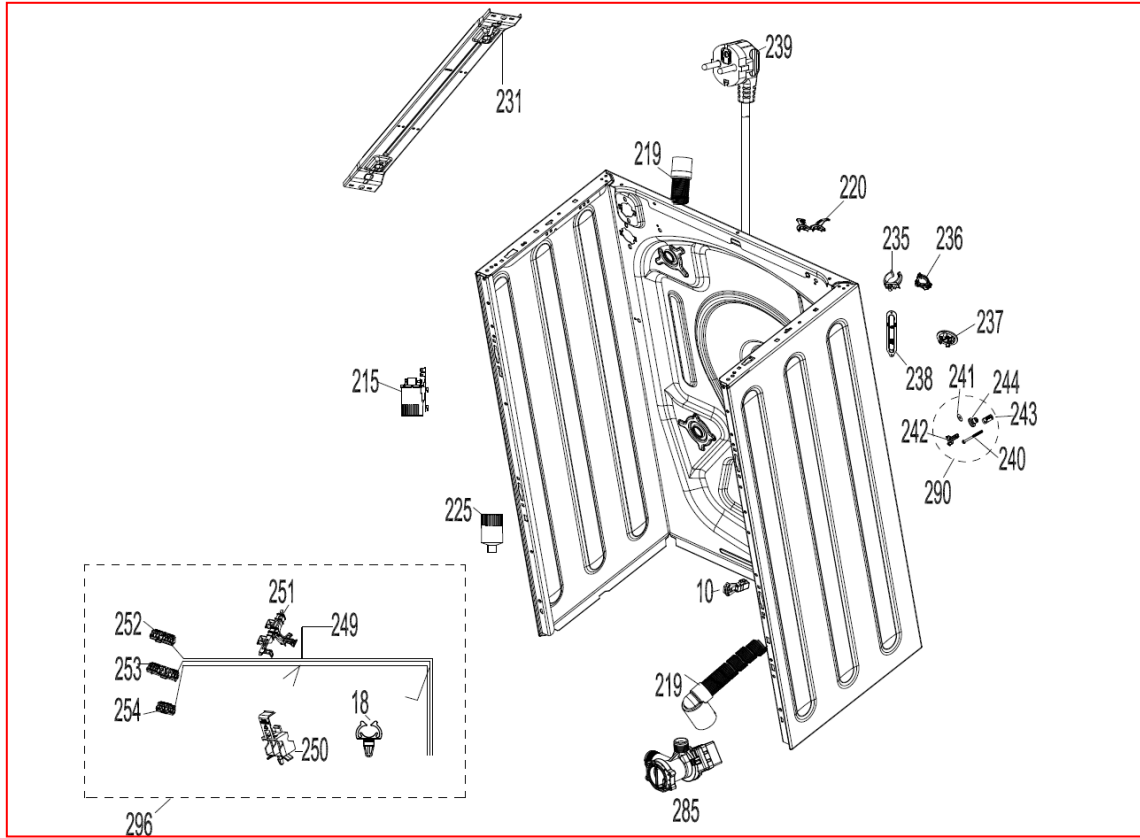

NO	PART NAME	QUANTITY
285	PUMP GROUP	1
220	DRAIN HOSE ROUTER PLASTIC	1
219	DRAIN HOSE	1
225	PRESSURE SWITCH	1
215	PARASITE FILTER	1
296	CABLE GROUP	1
249	CABLE HARNESS	1
250	CABLE HARNESS HOLDER PLS	1
251	CABLE HOLDER AND ROUTER PLASTIC-L	1
252	PCB BOX SOCKET HOLDER-S1	1
253	PCB BOX SOCKET HOLDER-S2	1
254	PCB BOX SOCKET HOLDER-S3	1
800	HANGER SPRING	2
221	HANGER SPRING SHEETIRON PLS.	2
231	SPRING HANGER SHEETIRON	1
236	DRAIN HOSE AND CABLE HOLDING PLS.	2
235	DRAIN HOSE HOLDING PLS	2
239	POWER CORD GROUP	1
222	PRESSURE SWITCH MOUNTING CLIP	1
238	SPEED CONTROL HOLE STOPPER	1
242	TRANSPORT SCREW PLASTIC A	4
243	TRANSPORT SCREW PLASTIC B	4
240	TRANSPORT SCREW	4
241	WASHER 8,6*36*2	4
231	TUB HANGER SPRING PART	1
237	TRANSPORT SCREW STOPPER	5
290	TRANSPORT SCREW GROUP	4
920	FRONT PANEL DROP FIXING PLASTIC	

**DOOR GROUP**

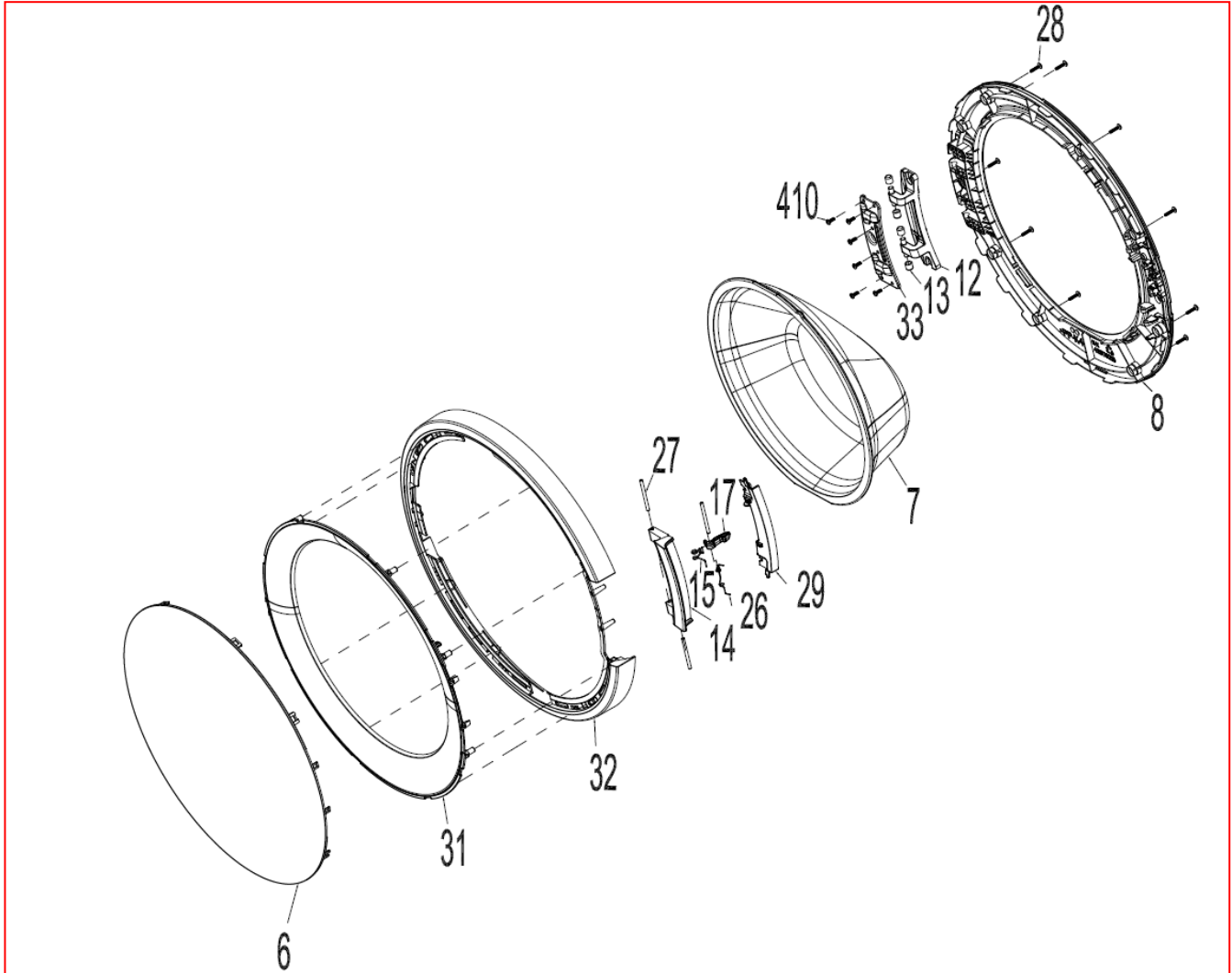

NO	PART NAME	QUANTITY
6	FRONT DOOR COVER	1
7	DOOR GLASS	1
8	INNER DOOR PLASTIC	1
12	HINGE	1
13	HINGE BUSH	4
14	DOOR HANDLE	1
15	HOOK SPRING	1
26	HANDLE SPRING	1
27	HANDLE PIN	3
28	SCREW 3,5X16 PAN HEAD WITH COLLAR UNDER HEAD SERRATED	9
29	OUTER DOOR PLASTIC INSERT PART	1
31	OUTER DOOR PLASTIC INNER FRAME	1
32	OUTER DOOR PLASTIC	1
33	DOOR HINGE SUPPORT SHEET	1
410	SCREW 4X12 PAN HEAD WITH COLLAR UNDER HEAD SERRATED	6
50	PORTHOLE GROUP (all parts)	1

**PACKAGING GROUP**

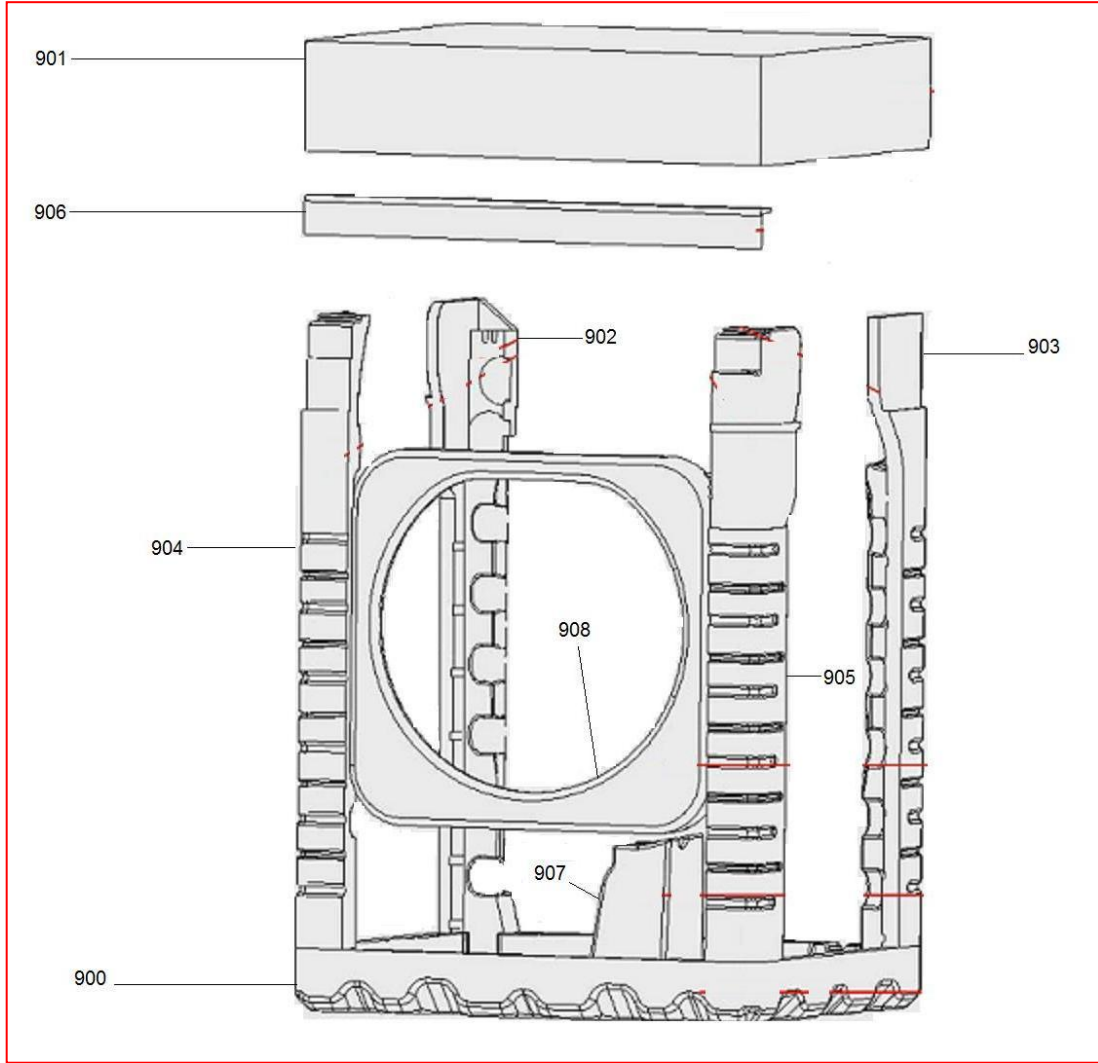

NO	PART NAME	QUANTITY
900	BOTTOM STYROFOAM	2
901	TOP CARTON	1
902	REAR STYROFOAM(LEFT)	1
903	REAR STYROFOAM(RIGHT)	1
904	FRONT STYROFOAM LEFT	1
905	FRONT STYROFOAM RIGHT	1
906	CORNER CARDBOARD	1
907	TUB SUPPORT STYROFOAM	1
908	PORTHOLE PRO. STYROFOAM	1



**ACCESSORIES**

995

996

997

998

NO	PART NAME	QUANTITY
995	ENERGY LABEL	1
996	LIQUID DETERGENT LEVEL PLATE	1
997	DRAIN HOSE COAT RACK	1
998	TRANSPORT SCREW STOPPER	4